

## microswitch

for NH fuse links

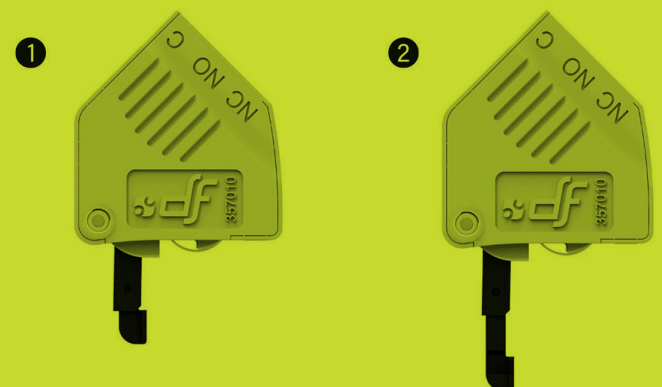

**PROTECTING  
THE WORLD**

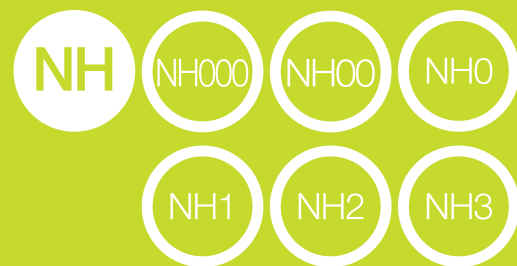



# microswitch

for NH fuse links



**RATED VOLTAGE**  
250V AC

**RATED CURRENT**  
5A



## Microswitch for NH fuse links with top indicator

Presence and fusing.

Manual assembly.

Compact design.

Two positions.

Manufactured with plastic materials with high temperature resistance and self-extinguishable.

All materials are according to the European Directive RoHS (Restriction of the use of certain hazardous substances in electrical material) and they are halogen free.



## Dimensions

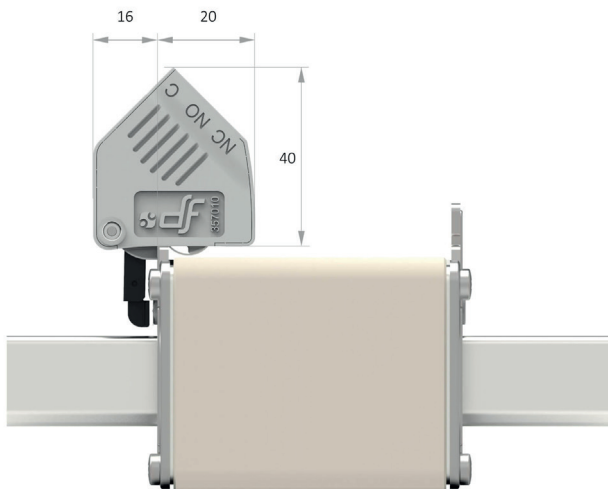

Weight 12gr

## Range

REFERENCE	DESCRIPTION	PACKING Uni /BOX
357010	MICROSWITCH FOR NH FUSELINKS NH000...NH3	1/12

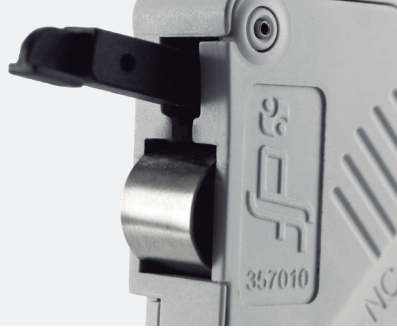

## Technical data

Rated voltage	250V AC	
Rated current	5A	
Use of microswitch in DC (utilization category DC-12)	5A	24V DC
	2A	48V DC
	0.4A	127V DC
	0.2A	240V DC
Impulse withstand voltage between power circuits and microswitch terminals	$U_{imp} > 8$ kV	
Dielectric withstand voltage between power circuits and microswitch terminals	7kV – 1 min. 50Hz	
Storage temperature	-40°C ... 80°C	
Operating temperature	-20°C ... 70°C	
Faston terminals dimensions	2,8 x 0,5mm	

## Change work position

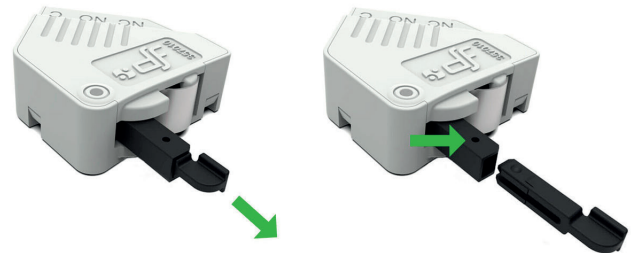

Extract mobile lever

Insert until position 2 (see arrow)

## Microswitch assembly



## Materials

Terminals	Brass
Contacts	Silver + nickel
Body	Thermoplastic with high resistance to temperature

## Positions

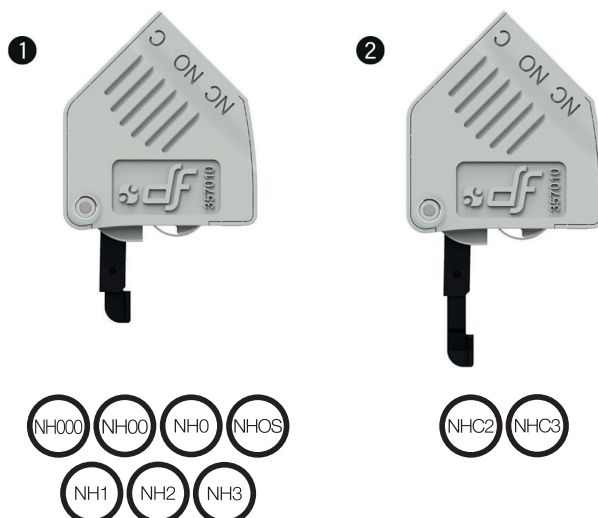

## IP20 NH fuseholder with microswitch

The microswitch can also be used in NH fuse links with IP20 protection. Ask for available references.

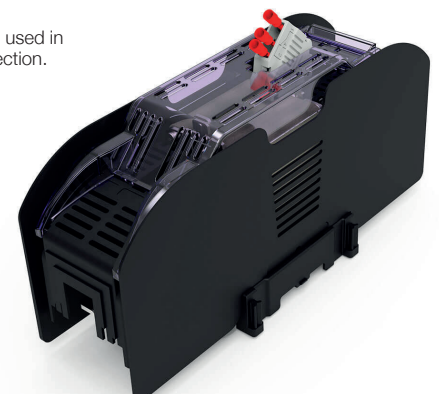



**HEAD OFFICE AND FACTORY**

SILICI, 67-69  
08940 CORNELLA DE LLOBREGAT  
BARCELONA  
SPAIN  
Tel. +34 93 377 85 85  
Fax +34 93 377 82 82

**INTERNATIONAL SALES**

Tel. +34 93 475 08 64  
Fax +34 93 480 07 75  
export@dfelectric.es

**NATIONAL SALES**

Tel. 93 475 08 64  
Fax 93 480 07 76  
comercial@dfelectric.es

[dfelectric.es](http://dfelectric.es)



The data reflected in this technical record are subject to the correct installation of the product in accordance with manufacturer's instructions, relevant installation standards and professional practices, maintained and used in applications for which they were made.

DF ELECTRIC retains the right to change the dimensions, specifications, materials or design of its products at any time with or without notice.

©2021 DF Electric. All rights reserved



**PROTECTING THE WORLD**

